

Farming Carp in Afghanistan

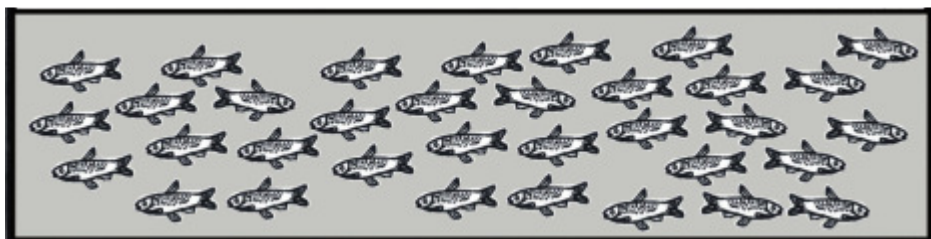

Ketabton.com

This manual was prepared by John A. Hargreaves, Ph.D. with the assistance of Elhamuddin Elham. Preparation of the manual was supported by the USAID-funded projects ASMED (Afghanistan Small and Medium Enterprise Development) and IDEA-NEW (Incentives Driving Economic Alternatives – North, East, and West) as implemented by DAI (Development Alternatives Inc.). Artwork was prepared by Nasrat Arts, Jalalabad.

Introduction

Fish farming can provide benefits for your family.



High-quality nutritious food.

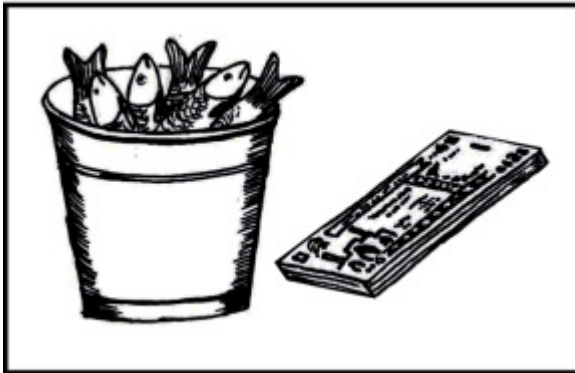

More income from farm land.

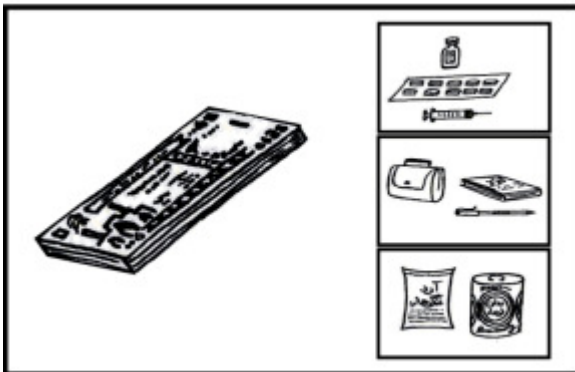

Cash money for household expenses.

Fish ponds can be built on land that is not good for growing crops, especially salty land.

Fish can be grown together with rice.

Fish can be grown together with animals, such as ducks and chickens.

Fish ponds are connected with other parts of the farm.

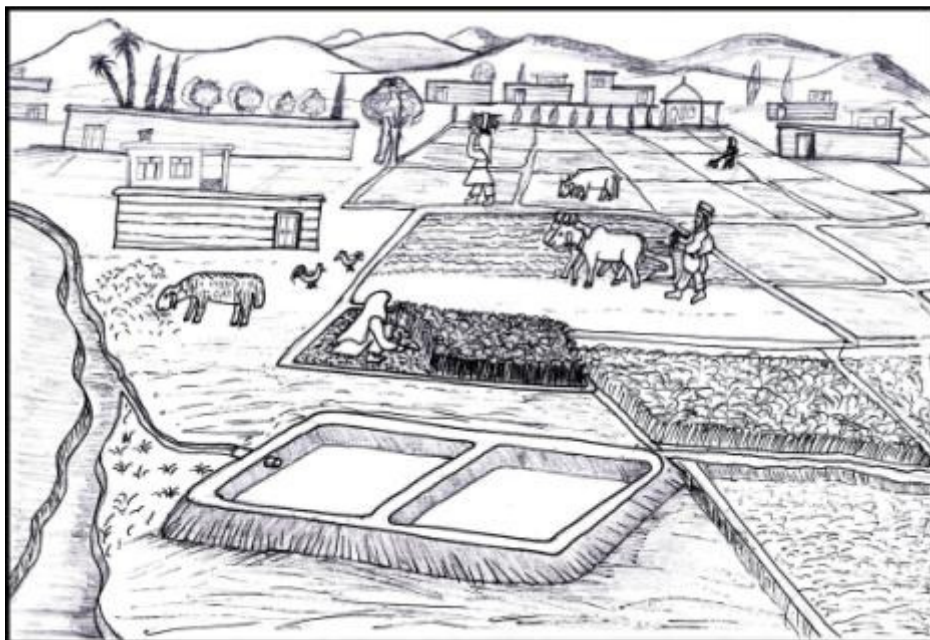

What is needed to grow fish?

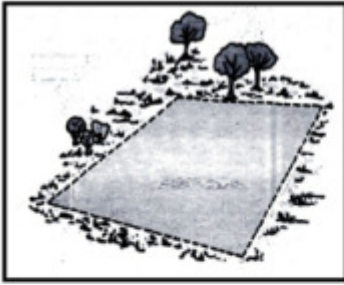

خُصْکَه

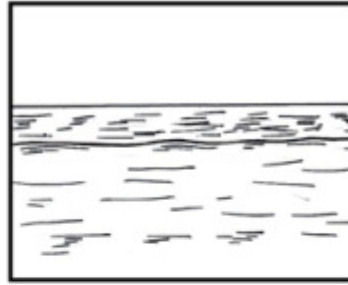

اوبه



مزدوز

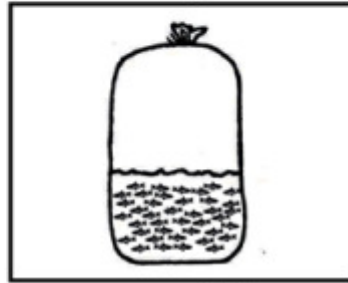

د کبانو بچوري

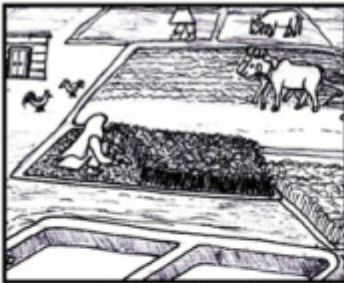

د کبانو لپاره خواړه

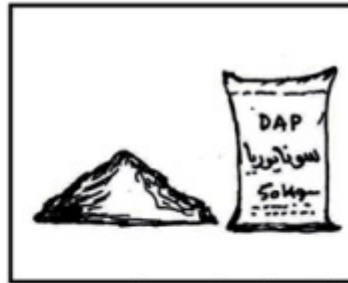

کيميا يې او حيواني سره

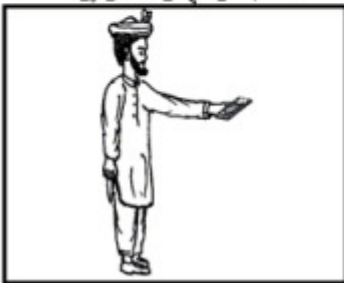

پيسی

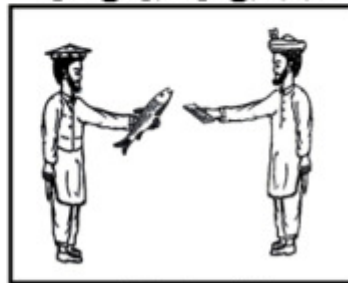

بازار يا مارکيت

How to decide where to build a fish pond?

Ponds should be located near markets, especially near towns.

Build the pond near the farm house.

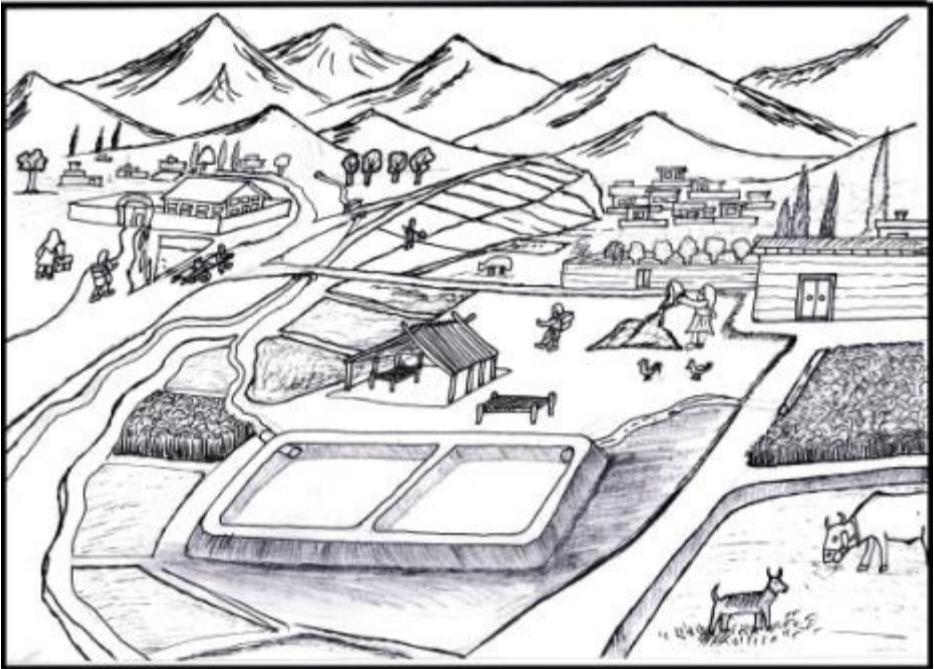

Someone should be always living near the fish ponds.
Fish can be stolen at night.

Land for the pond should be open and without trees.

The land for the pond should be lower than the water source.
Ponds should drain without pumping.

The place for the pond should not flood during the monsoon.
If the pond is built in a low area, fish might escape if the pond floods.
Wetlands are good places to build ponds if they do not flood.

The main things to check first are water, soil, and slope.

Water

There must be enough water to fill the pond and add water when needed.

Enough water to fill the pond within three days is needed.

A flow of 1 m³ every 2 minutes should be sufficient for a 1 jerib pond.

Water should be available all times of the year.

Water should not have a bad smell, color, or taste.

Water should not be too muddy.

Water from rivers and irrigation canals might be muddy during the rainy season.

Soil

The soil must hold water.

The soil must not have too many stones or too much sand.

Use these tests to see if soil is good for building fish ponds:

The squeeze test.

Add enough water to a handful of soil until it is moist (not wet).

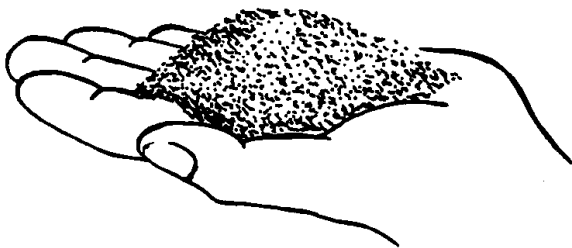

Squeeze the soil.

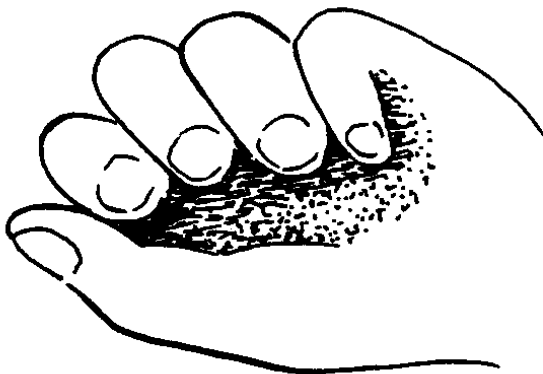

If the soil holds its shape, then it is good for building ponds.

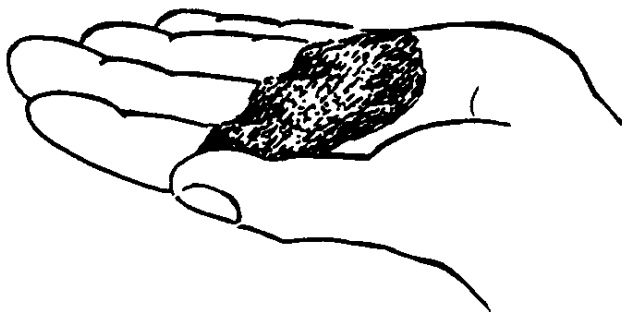

The water holding test.

Dig a hole about 1 m deep, about as deep as your waist.



Fill the hole with water and wait for one day.

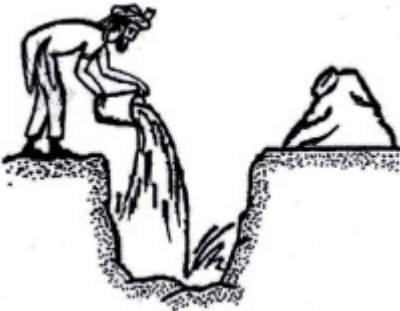

After one day, fill the hole again with water.

Wait one more day.

If the hole holds water, then the soil is good for building ponds.

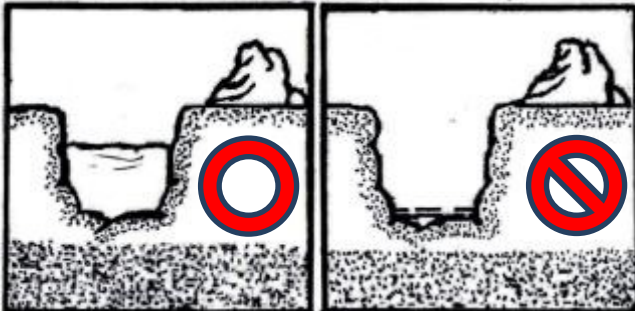

Slope

A pond built on land with a gentle slope is easy to drain.

Land with a slope of 2 to 4 m of drop for every 100 m of distance is best for building ponds.

A pond built on land with a gentle slope means that the amount of soil that must be dug is not too much.

Pond features

Ponds of $\frac{1}{2}$ to 1 jerib are a good size.

The pond should be a rectangle or square.

Ponds should be 0.5 to 1.0 m deep in shallow end and 1.2 to 1.5 m in deep end.

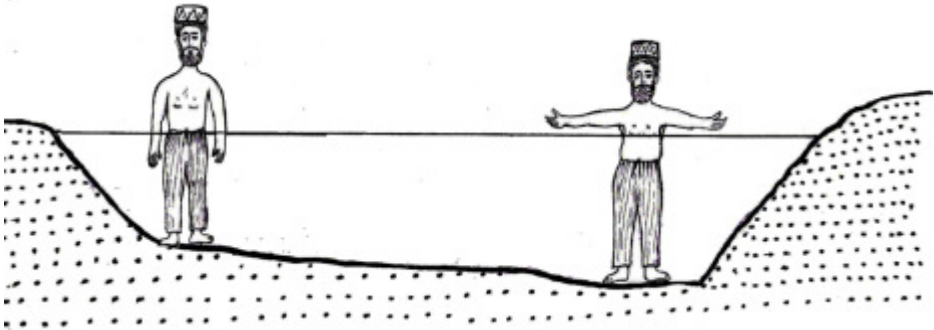

Pond dikes should have inside slopes of 2 to 1 or 3 to 1.

Outside slope can be steeper than inside slope, about 1.5 to 1 or 2 to 1.

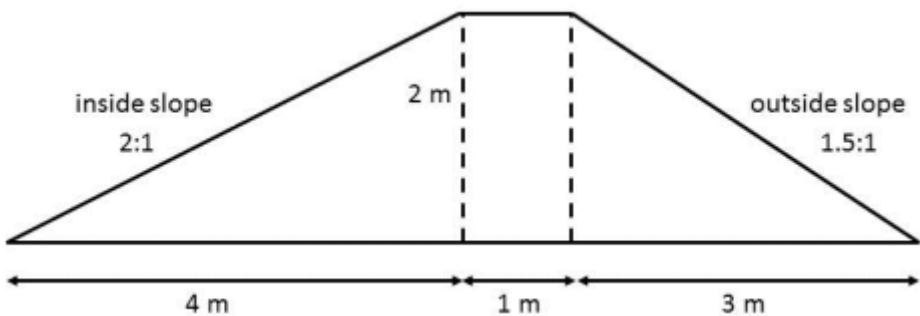

The height of the dike should be 30 to 50 cm above the water level.

The top of the dike should be 1 to 1.5 m wide and flat and smooth all around.

The bottom should have a gradual slope toward the drain.

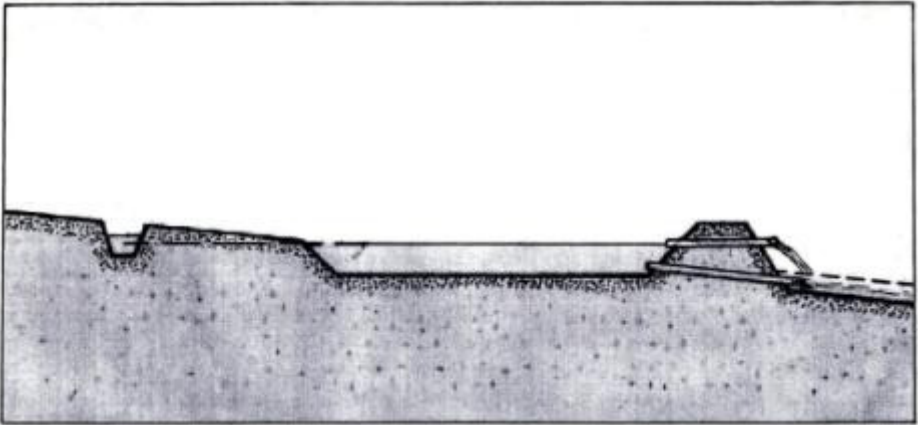

If possible, build pond to take advantage of water mixing by the summer wind.

Orient the long side of the pond in the same direction as the most common wind in the summer.

The pond must have a structure or gate to control water flow to the pond.

There should be enough water to fill the pond within three days.

You should be able to drain the pond within three days, preferably without pumping.

Each pond should have its own inlet and outlet.

Water should not flow from one pond to another.

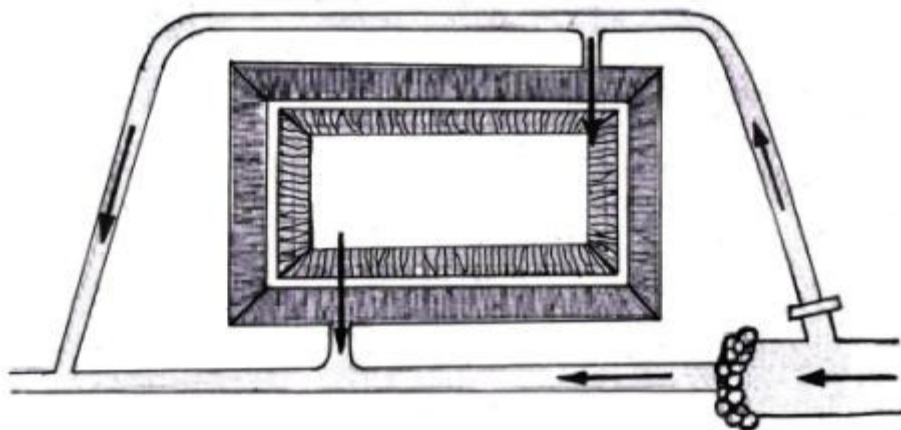

There are many ways to screen the inlet water.

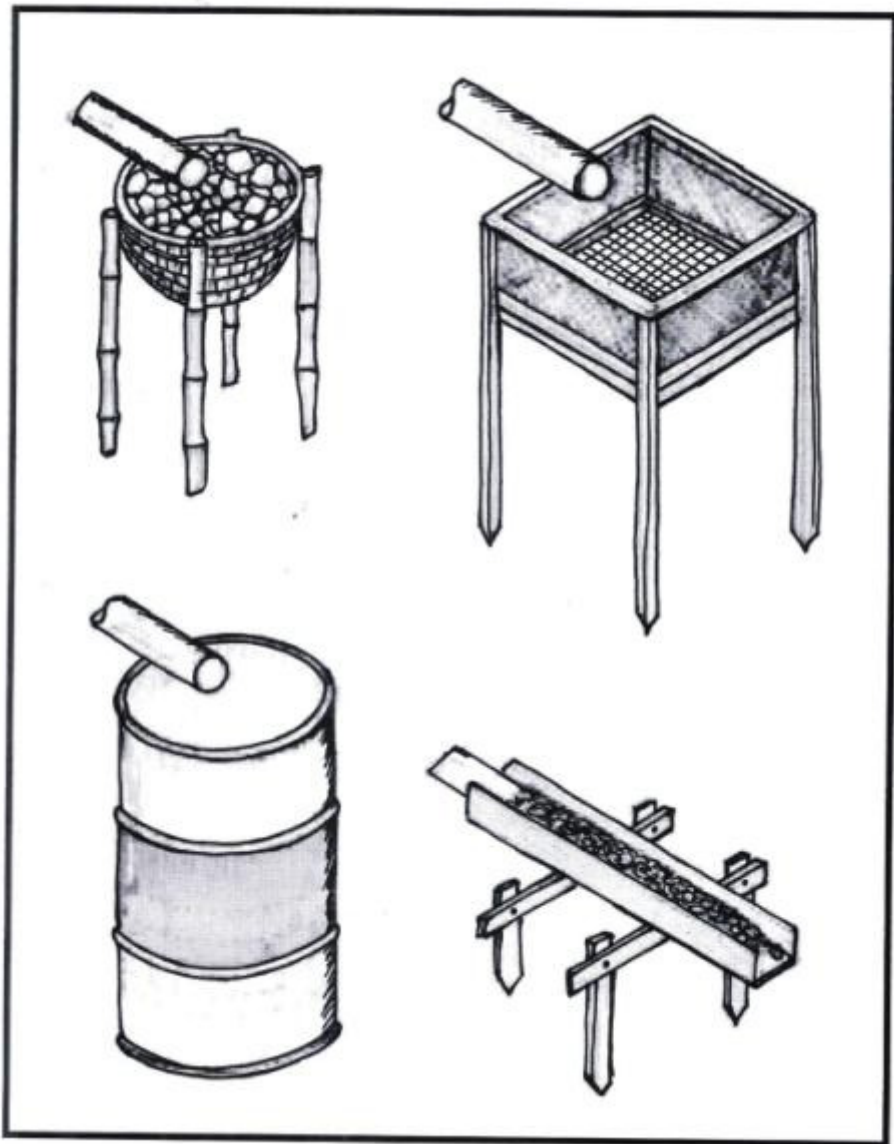

Pond construction

Clear the area inside the sticks of trees and grass.

Remove trees, brush, roots and large stones from site.

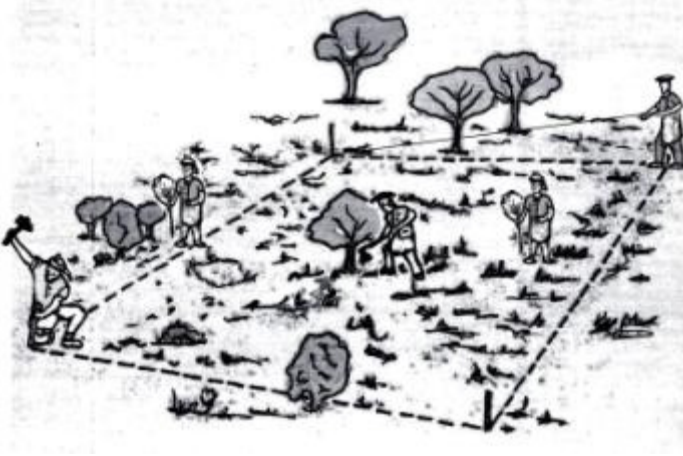

Remove the top layer of soil and make a pile away from the future pond.

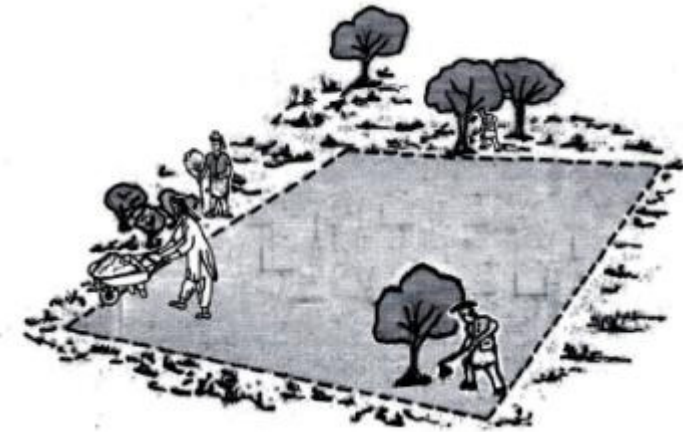

Mark the outside corners of the bottom of the dike with sticks.

Mark the center-line of the top of the dike with sticks.

Mark the inside corners of the bottom of the dike with sticks.

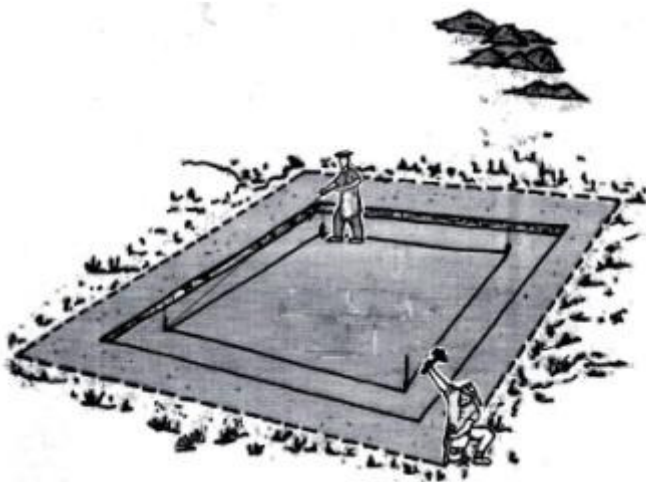

Dig the drainage ditch.

Ponds can be dug in different ways.

- 1) Partly above and partly below original ground level.
-the best option

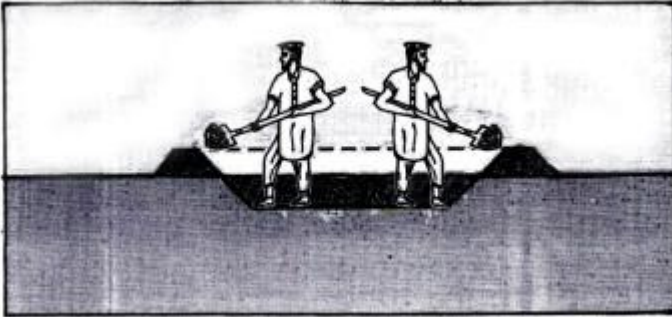

- 2) Completely above the ground level.
-must bring in soil from outside

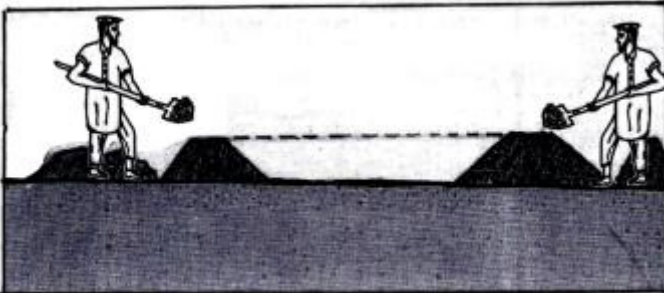

- 3) Below the ground level.
-often difficult to drain

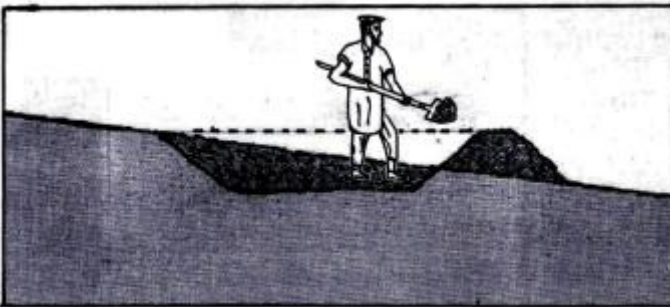

Dig the pond by removing soil from the central area, about 20-30 cm at a time.

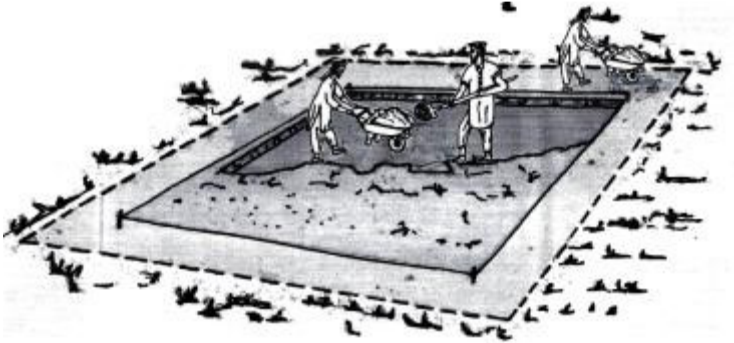

Use this soil to make the dike to hold water.

Make the dike by adding soil in 20-30 cm layers (about half the height from the ground to your knees).

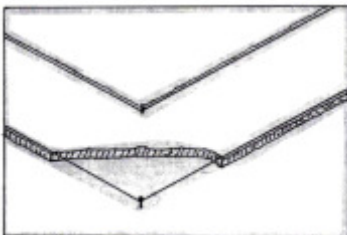
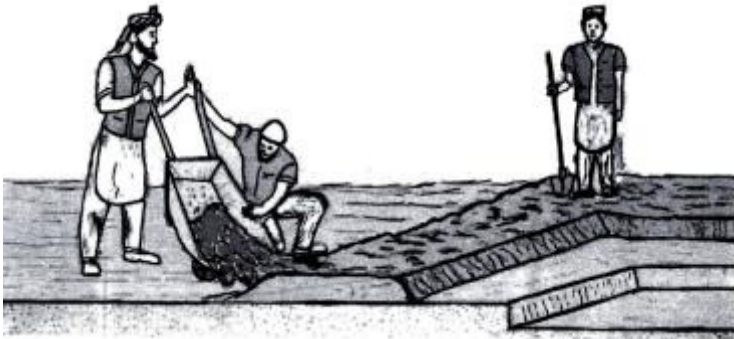

After placing 20-30 cm of soil on the dike, compact each layer with a heavy log or piece of wood.

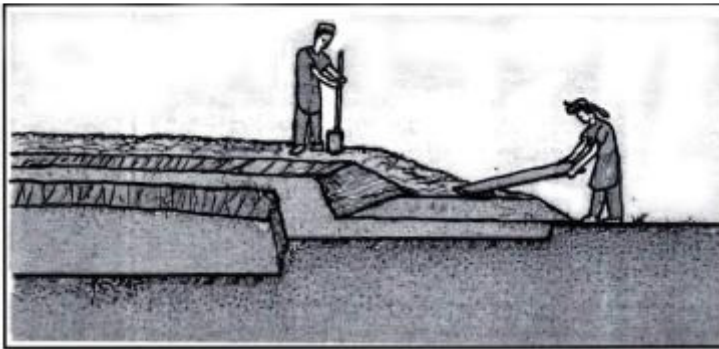

Build up the dike in layers until the inside of the pond is dug out and the dike is the proper height.

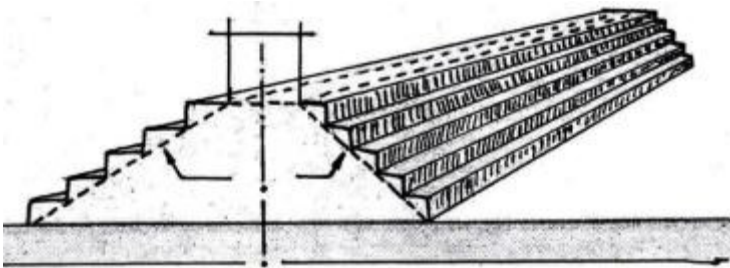

Dikes should be 30-50 cm higher than the water level.

Add more soil to allow for some additional settling of the dike over time.

Do not add additional soil once the desired height is reached.

Make the slope of the dikes after the main part of the pond has been dug.

Form the inside slope.

Form the outside slope.

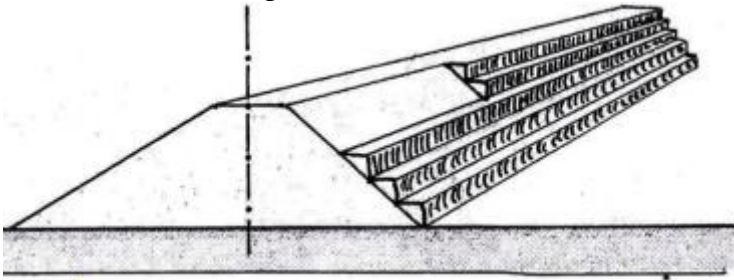

Use a triangle to slope the dikes properly.

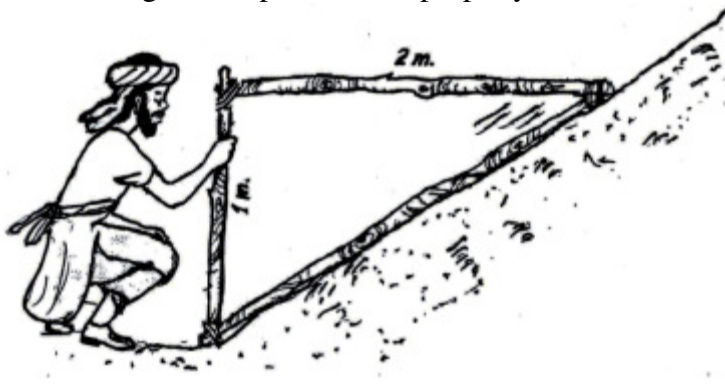

The bank can be steeper on the outside than the inside.

Make the pond bottom smooth with a slight slope (10 to 20 cm for every 100 m distance) from the shallow to the deep end.

Dig a small ditch from the center of the pond to the lower end to help drain the pond.

Build the pond outlet.

The pond outlet should be at the opposite side of the pond inlet.

The outlet pipe should be 6-10 m long and 20-25 cm in diameter.

Dig a trench at the lower end of the pond for the outlet pipe.

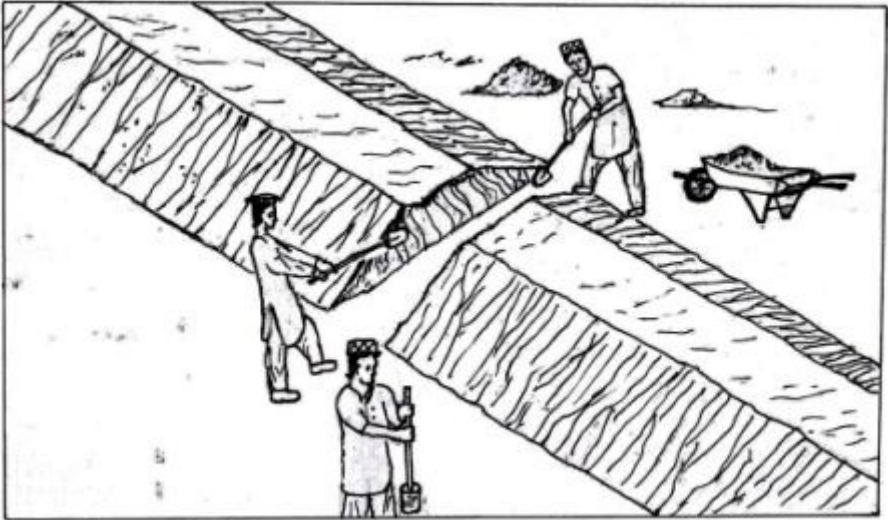

Place the outlet pipe in the trench and cover again with soil.

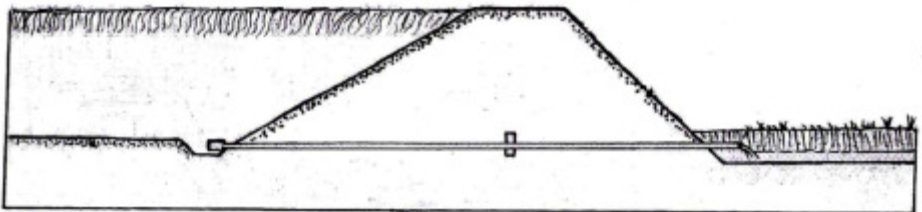

Dig the water diversion canal for the main water supply.

Dig secondary water supply canals, if necessary.

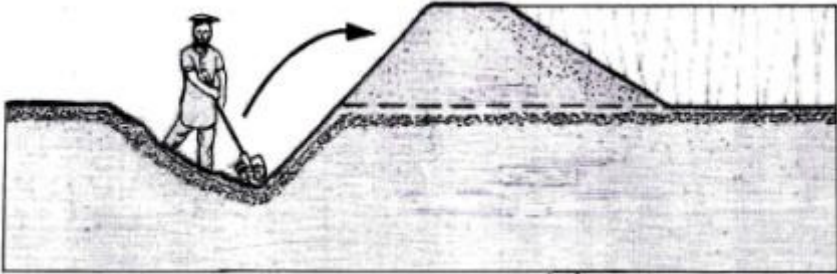

The pond inlet can be built in different ways.

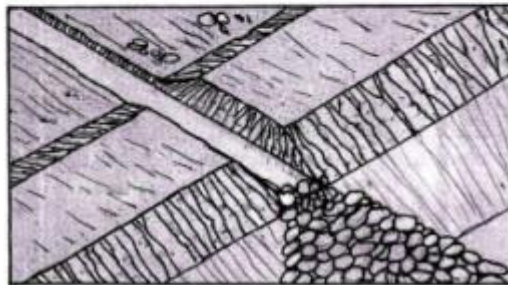
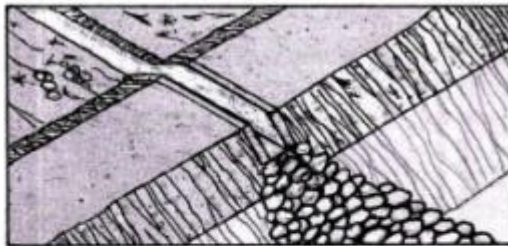
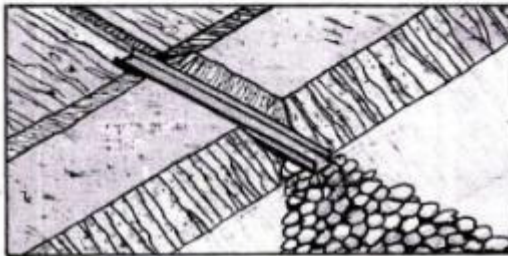
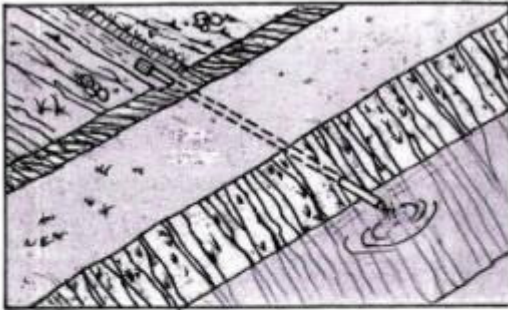

The inlet pipe should be about 3 m long and 20-25 cm in diameter.

The inlet should be 10-15 cm above the water level of the pond.

Cut a trench in the dike of the upper end of the pond, place the inlet pipe there and cover again with soil.

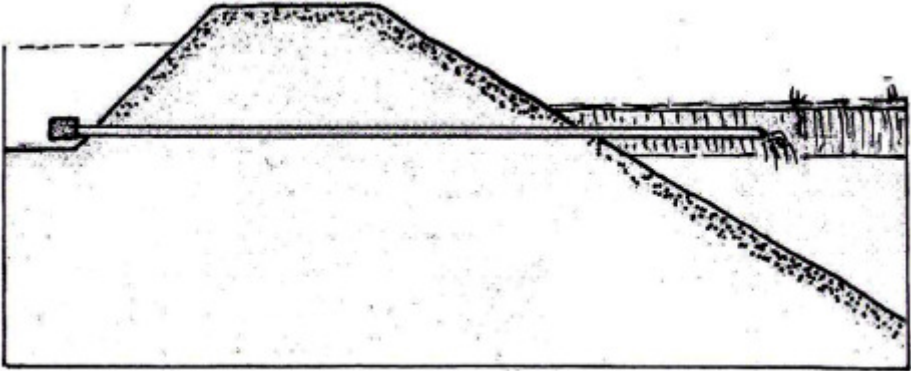

Screen the inlet pipe and outlet pipe.

Add a structure to screen the inlet water to prevent wild predator fish, such as snakehead fish, from entering the pond.



Screens can be made many different ways. This is one way.

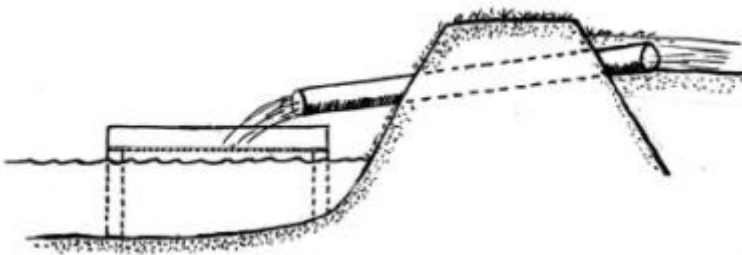

Screen the outlet pipe to prevent fish from escaping.

Return topsoil to the banks.

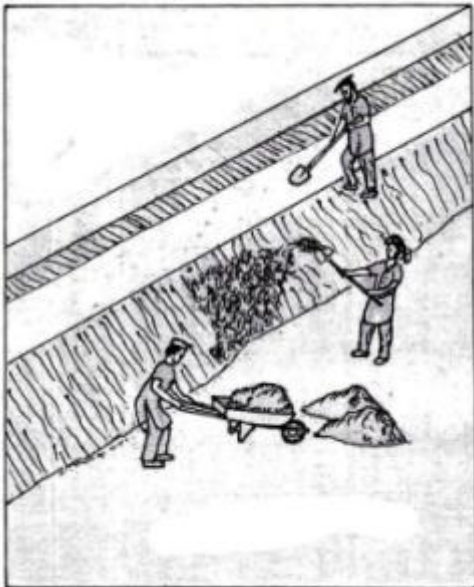

Plant grass on pond dikes to control soil erosion.

Vegetables can be planted on pond dikes.

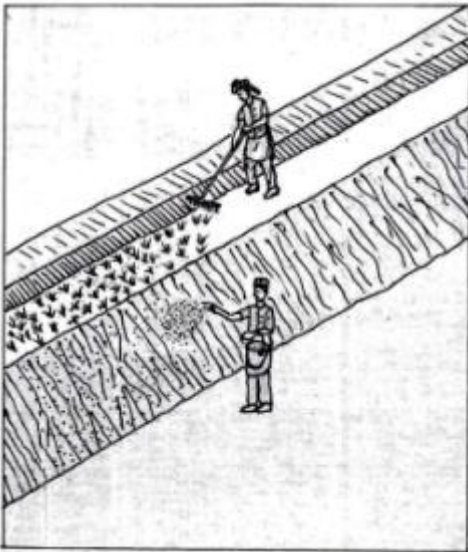

Do not allow big trees to grow around the pond and shade the water.

Pond Preparation

The goal of pond preparation is to make water green.

Green water means that there is plant food for fish to eat.



For new ponds:

Liming can do many good things to make the pond produce more fish. Different kinds of lime can do different things.

Agricultural lime is inexpensive and can help to make the pond green.

Quicklime and hydrated lime can be used between crops to treat the bottom for wild fish, some pests, and diseases.

Ashes from cooking fires can be used as a source of lime.

It is better to add lime to soil when pond is empty than adding to water when pond is full.

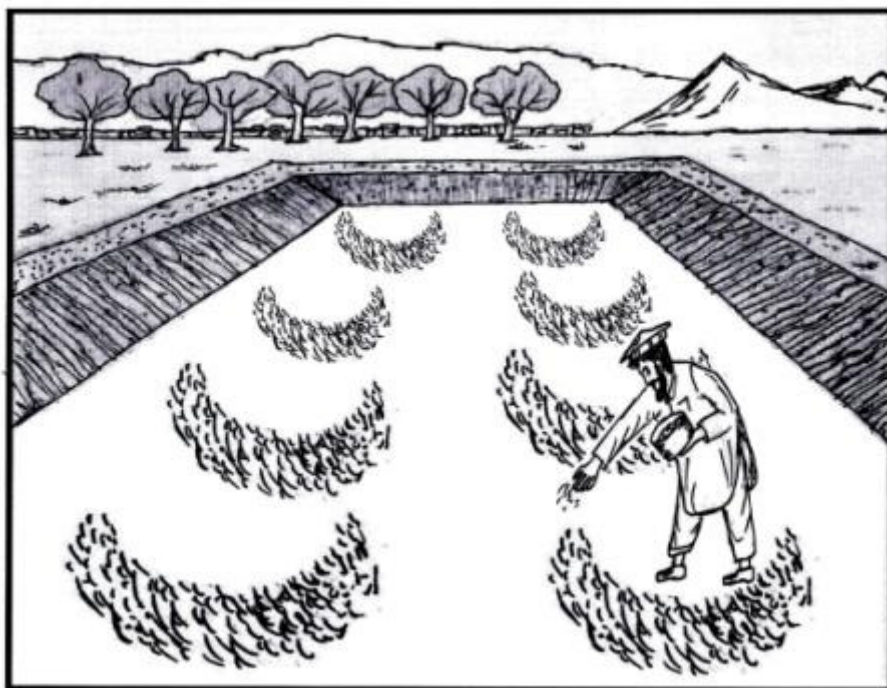

For new ponds, add 500 to 1000 kg of agricultural lime per jerib (25-50 kg per 100 m²).

New ponds need more lime than old ponds.

For old ponds, add one of these:

<i>Liming material</i>	<i>kg per 100 m²</i>	<i>kg per jerib</i>
Quicklime	5-15	100-300
Hydrated (builder's) lime	8-20	150-450
Agricultural lime	10-25	200-500
Wood ashes	20-40	400-800

Leave lime in place for 2-3 days before filling pond.

Use animal dung in the beginning of a crop to make the pond green.

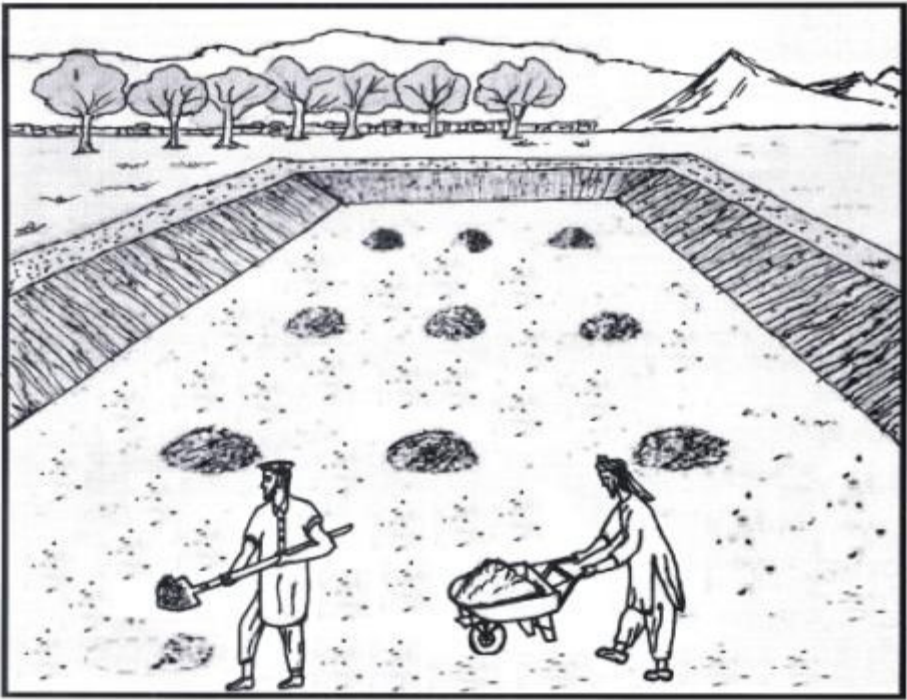

Also add one kind of these dungs before filling pond with water.

<i>Dung</i>	<i>kg per 100 m²</i>	<i>kg per jerib</i>
Cow or buffalo	20-30	400-600
Chicken	10-15	200-300

Place a large flat stone beneath the inlet pipe to avoid erosion when filling pond.

Fill the pond to 1/3 of full depth, about knee high.

Wait 2-3 days until water begins to turn green.

Then, add water every 3-4 days until the pond is full.

After the pond is full, add inorganic fertilizer, such as DAP and urea.

Fertilizer	<i>g per 100 m²</i>	<i>kg per jerib</i>
DAP	1000	20
Urea	1000-1500	20-30

For DAP, soak fertilizer overnight in a drum of water.

Adding dry DAP directly to the pond is not effective and is a waste.

For urea, add to a drum of water and stir to dissolve.



Apply dissolved fertilizers to pond by spreading around the water surface.

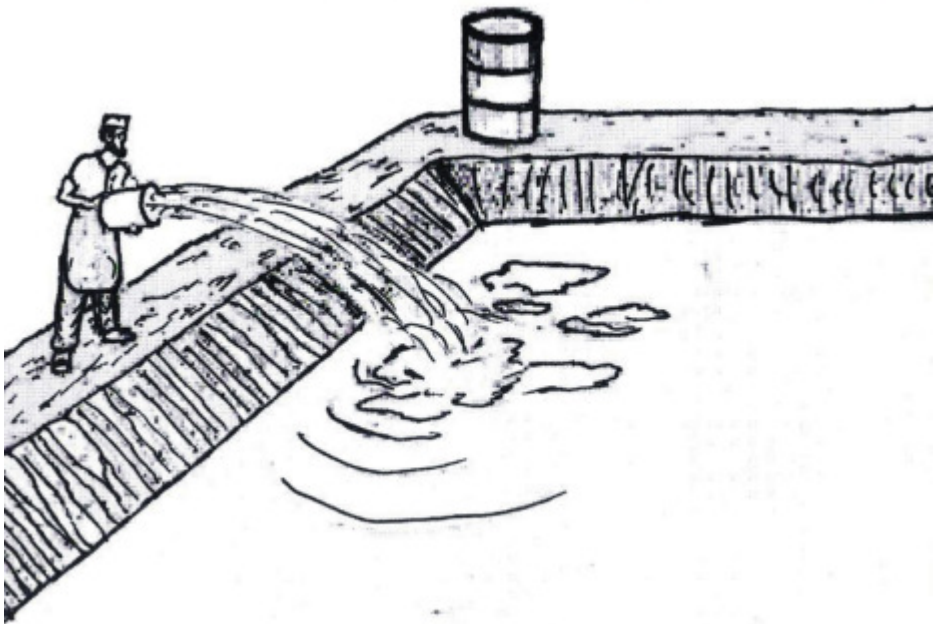

After the first dose of fertilizer, add this much fertilizer every one or two weeks.

Fertilizer	<i>g per 100 m²</i>	<i>kg per jerib</i>
DAP	200-400	4-8
Urea	300-500	6-10

Add this amount every one or two weeks to keep the water green.

Keep a moderate color of green in the water, not too thick and dark.

If the water is very green, it is not necessary to add more fertilizer.

Put your hand in the water up to your elbow to check the color.

Usually the pond will turn green 4-7 days after the first dose of fertilizer.

Wait until pond water becomes green before stocking baby fish.

Put baby fish in the pond within seven days of filling with water.

For old ponds:

After harvesting fish, drain or pump out all water from the pond.

Kill fish that remain in puddles with powdered (hydrated) lime or bleaching powder.

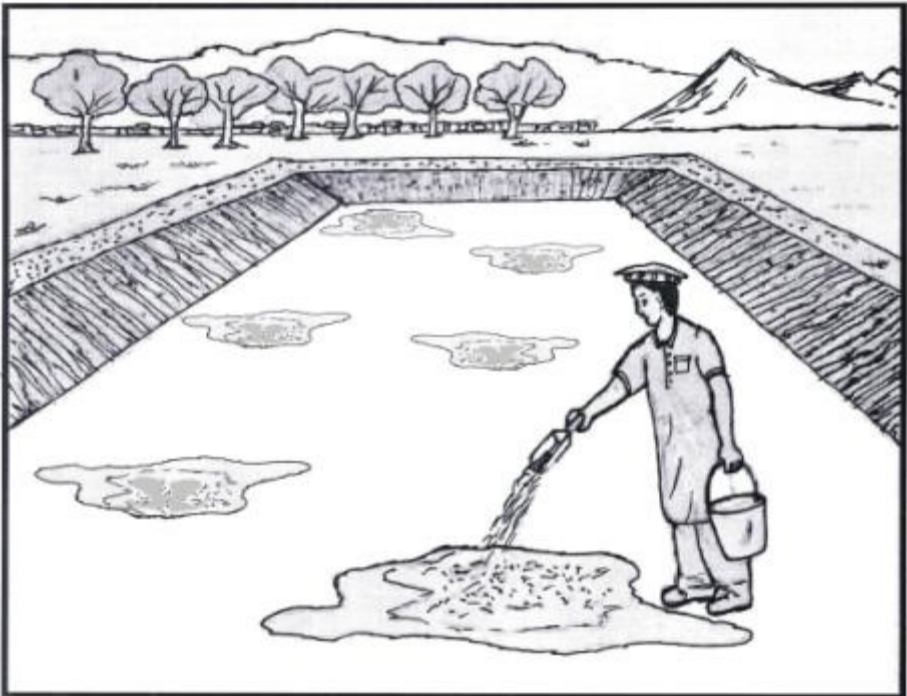

Kill predators like snakehead fish, frogs, and snakes.

Dry the pond bottom for at least one week in the hot sun.

When the pond is dry, plow the soil of the bottom.

If you use a lot of muddy water, then soil will build up on the pond bottom.

Remove accumulated soil between crops.

Use this soil to repair pond dikes and restore the proper dike slope.

Do not place extra soil on top of the dike.

Remove soil if necessary.

Then, follow the program of liming and fertilization for new ponds.

Fish to Grow

	نوم	چیری چی د دند په اوبو کی ژوند کوی	څه چی خوری
	د وینو کب	د کبانو د دند پاسنی برخه په دند کی د اوبو برخه یا طبقه	رشقه شفتل
	سپین یا سلوری کب	د کبانو د دند پاسنی برخه په دند کی د اوبو برخه یا طبقه	اوبری یا شنی اوبه
	ر هو کب	په دند کی د اوبو برخه یا طبقه د کبانو د دند بنکتی برخه	اوبری یا شنی اوبه
	موری کب	په دند کی د اوبو برخه یا طبقه د کبانو د دند بنکتی برخه	هر هغه شی چی د کبانو د دند بنکتی برخی ته ورولیری یا خوسا (خراب عضوی مواد)

For each jerib, stock 2000 fish.

There are many options for stocking different numbers of fish.

<i>Fish</i>	<i>Option 1</i>	<i>Option 2</i>	<i>Option 3</i>
Grass carp	2000	1000-1200	1000
Silver carp		800-1000	500
Rohu			250
Muree			250

Stocking Baby Fish

Stock baby fish into a small pond for 1-2 months before stocking the big pond.

About 100 m² of a small pond can support fish for a 1 jerib big pond.



Add kerosene to the pond to kill air-breathing insects one day before stocking baby fish.

Add kerosene at 0.5 L per 100 m² (10 L per jerib).

Baby fish from the hatchery are usually transported in plastic bags.

Receive the fish early in the day (0900 to 1100 h) when the air and water are cool.

Place the plastic bag with the fish in the pond for 10-15 minutes.

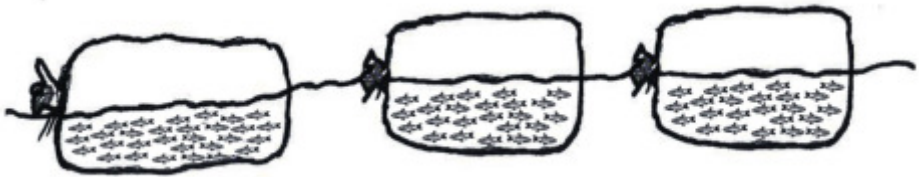

Open the bag and check the temperature of the water in the bag with your hand.

Also check the temperature of the water in the pond.

The temperature of the water in the bag and in the pond should be the same.

Slowly add some water from the pond to the plastic bag to make the temperature the same.

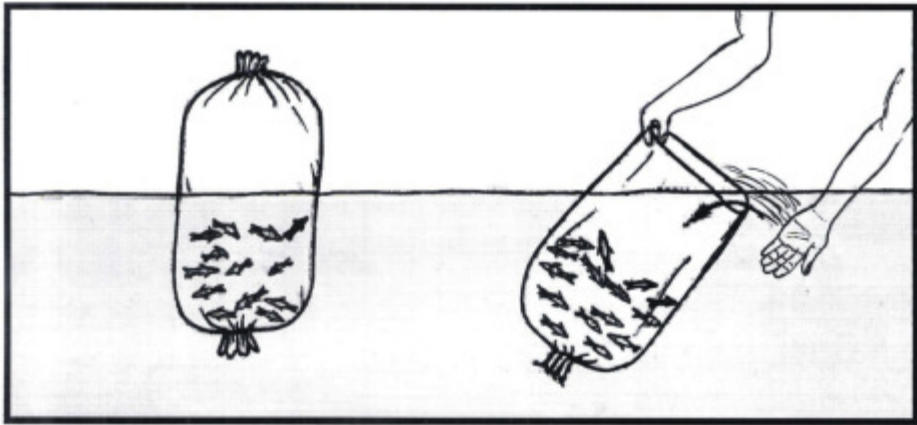

Release baby fish into the pond.

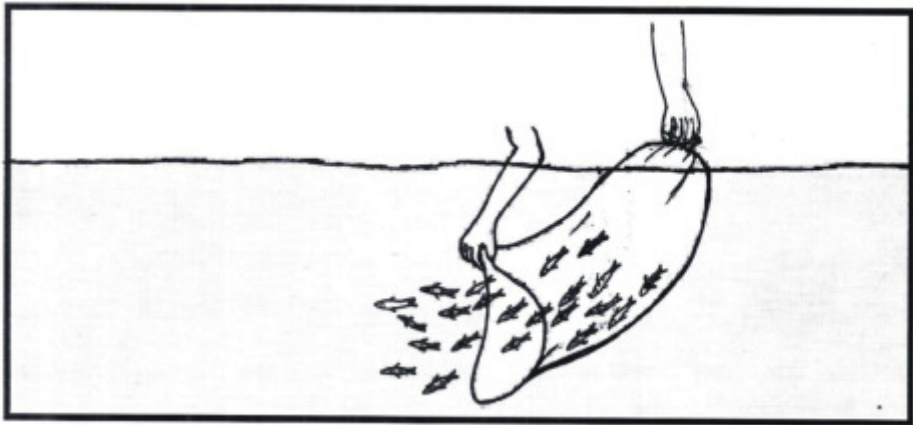

Feed wheat bran every day to baby fish at 20 to 40 kg per jerib (1 to 2 kg per 100 m²).

Fish should be 5 cm (about as long as your fingers) before stocking in the big pond.

Feeding

For grass carp, the best foods are crop plants.

Alfalfa, clover, grass, and young corn plants are good food for grass carp.

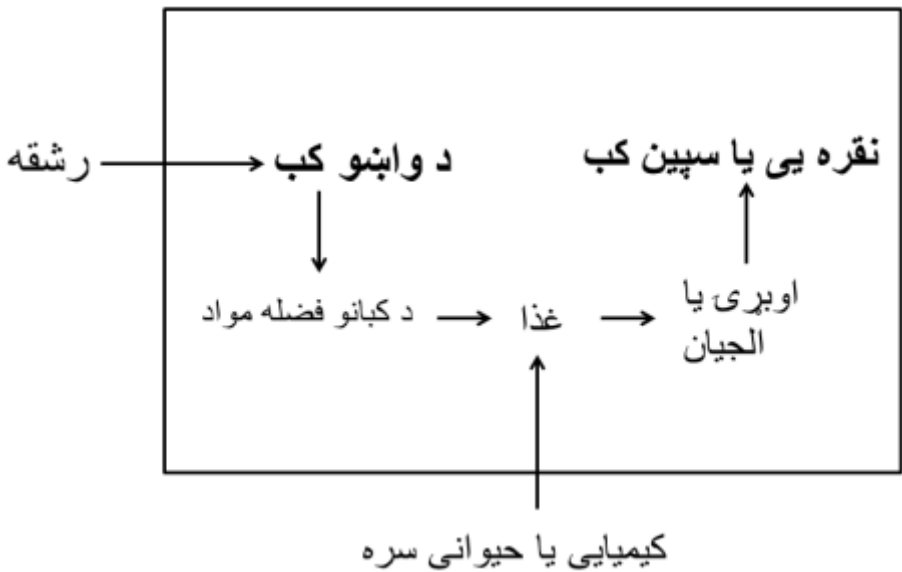

Add about 20-25 kg of fresh alfalfa per jerib each day.

One jerib of alfalfa can support two jerib of fish pond.

One jerib of alfalfa can support one jerib of fish pond plus one cow.

Wheat bran, rice bran, and cottonseed meal from mills are also good food.



Stale bread and other scraps from the household kitchen can be fed to fish.



For silver carp, green water (natural plants) is the best food.

Water temperature has a very strong effect on fish growth.

Growth is best when water is warm.

تودوخه یا حرارت		وده یا نمو	
ډیر گرم	[Red to Yellow Gradient]	[Yellow to Green Gradient]	رو / لږه
گرم			تیزه / ښه
لږ گرم	[Blue to Purple Gradient]	[Green to Yellow Gradient]	ډیره تیزه / ډیره ښه
لږ سور یا یخ			تیزه / ښه
سور یا یخ	[Purple to Red Gradient]	[Yellow to Red Gradient]	رو / لږه
ډیر سور یا یخ			هیڅ وده نه کوی

Feed two times every day: morning (9-10 am) and afternoon (4-5 pm).

Feed fish in the same place every time.

Watch fish feeding.

If fish finish feeding in less than 30 minutes, add more food.

Add one of these manures every month.

Dung	kg per 100 m²	kg per jerib
Cow or buffalo	15-20	300-400
Chicken	5-10	100-200

Caring for Fish

Every day

Check flow of water to pond.

Check water level and add water if necessary.

Check if pond is leaking.

Clean inlet and outlet screens.

Check behavior of fish (gulping for air) in the early morning.

Watch the fish when they eat.

Evaluate signs of sickness.

Remove sick or dead fish.

Check water color. It should be green.

Water should not be brown (muddy).

Look for presence of red scum on pond surface.

Check density of algae (transparency test) and presence of red scum.

Water clarity can be checked by putting your arm in the water up to the elbow.



You can also use a long stick to measure water clarity.



If you are able to see your hand (transparency around 25-30 cm), then the water is green enough and there is a good level of natural food.

If you cannot see your hand (transparency less than 25 cm), then water is too green.

Look at the fish in the early morning to see if they are gulping air.

Exchange water.

If you must put your arm all the way into the water before your hand disappears (transparency greater than 30 cm), then the water is not green enough.

Add more manure or fertilizer (DAP and urea).

Check for signs of pests or predators (such as footprints) and remove them.

Look for signs of theft/poaching.

Inspect pond embankments for holes or damage.

Do not let cows graze on pond banks because they can cause damage. Grazing sheep on pond banks is acceptable.

Every week

Inspect water supply and drainage canals.

Walk around inside the pond near the feeding area to check for accumulation of feed.

This will help you learn how to feed the fish the proper amount.

Reduce feeding if waste feed is accumulating.

Maintaining good water quality

Oxygen in water is needed for fish to live and grow.

Oxygen is produced by plants in the green water when the sun is shining.

During the day, when the sun is shining, the oxygen concentration is increasing.

During the night, when it is dark, the oxygen concentration is decreasing.

The lowest oxygen concentration occurs around sunrise/dawn.

If the oxygen concentration is too low, fish will come to the pond surface and gulp for air, usually late at night or early in the morning.

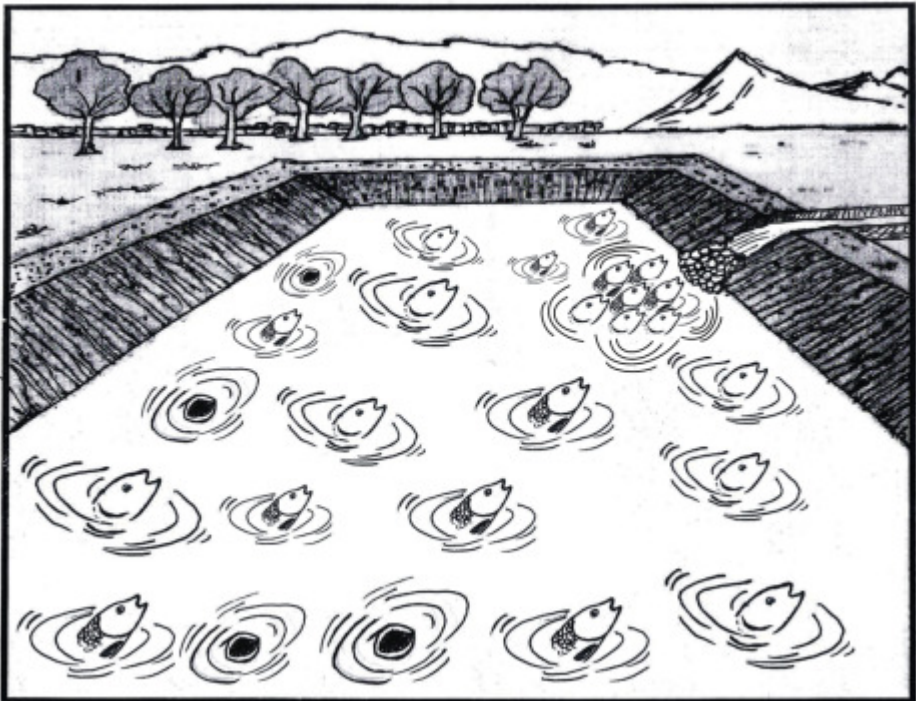

If oxygen concentration stays low for too long, fish will not eat well and could get sick.

If oxygen concentration becomes extremely low, fish might die.

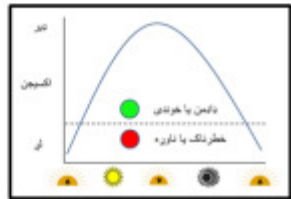
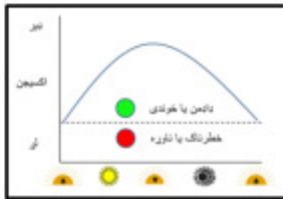
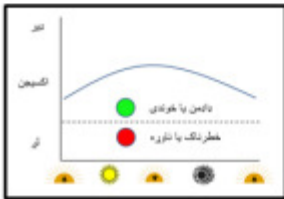
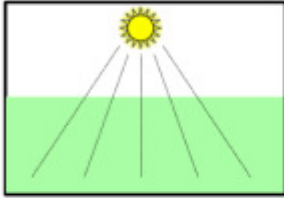

no oxygen problems

oxygen problems sometimes

oxygen problems every night

add fertilizer

do nothing

exchange water

A red scum on the pond surface indicates a problem with low oxygen concentration.



Use water exchange when fish are gulping for air at the surface or when a red scum appears.

To exchange water, reduce the pond level by half.
Then, refill the pond with new water.

It should not be necessary to flow water through the pond during the first few months.

Using muddy water

Muddy water is caused by soil particles suspended in water.



Muddy water causes many problems in fish ponds.

When mud in water settles in the pond, the water depth is reduced.

Water will not become green (food for fish) if water is too muddy.

Plants will not produce much oxygen if water is too muddy.

Muddy water can hurt gills that fish use to get oxygen from the water.

Use a small basin to settle heavy soil particles before adding water to big pond.



Dry and clean out small basin between fish crops.

Sickness and Health Management

A few dead fish are normal.

Large numbers of dead fish indicate a more serious problem.

If the number of dead fish is increasing every day, there may be sickness.

Preventing sickness is less expensive than treating sickness.

Good feeding and good water quality is the best approach to preventing sickness.

If fish are not fed enough and water quality is poor, fish might get sick.

The oxygen concentration must always be good.

Oxygen concentration can be a problem when the weather is hot.

If fish are gulping air in the early morning, they could become sick.

Observe fish behavior, especially at feeding.

Abnormal behavior include:

Gulping for air at the surface in the early morning

Many fish crowding near the water inlet

Unusual swimming, such as swimming in circles or swimming alone, or swimming slower than others.

Rubbing the body against an object in the pond.

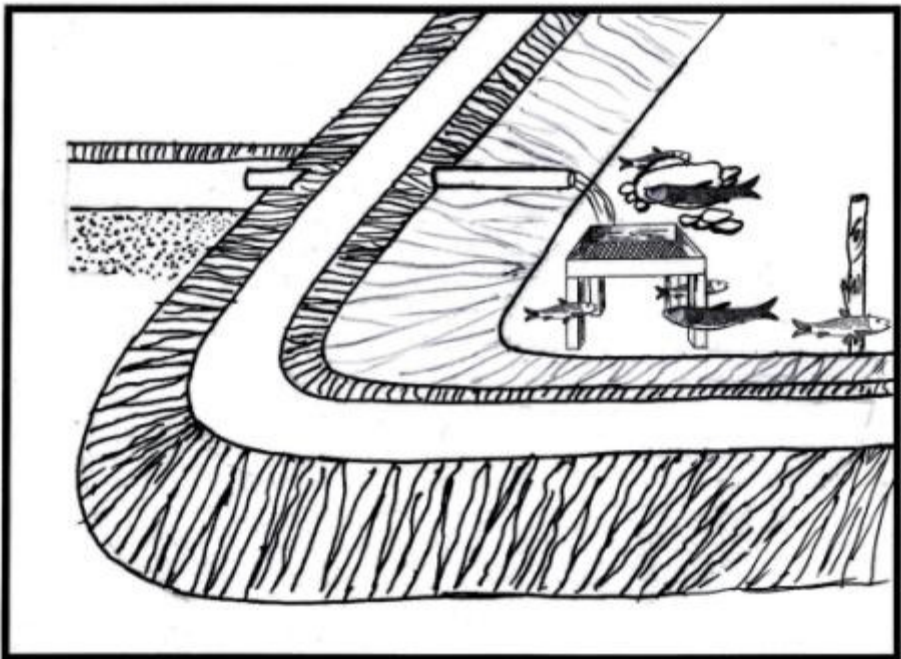

Sick fish may have an unusual appearance.

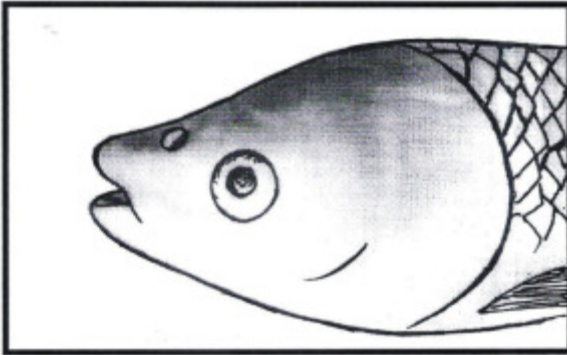

Very dark color

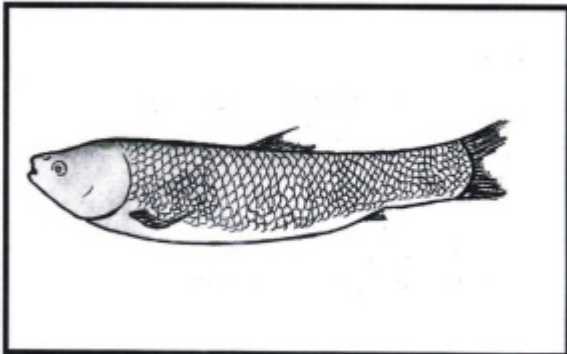

Fins that are eroded

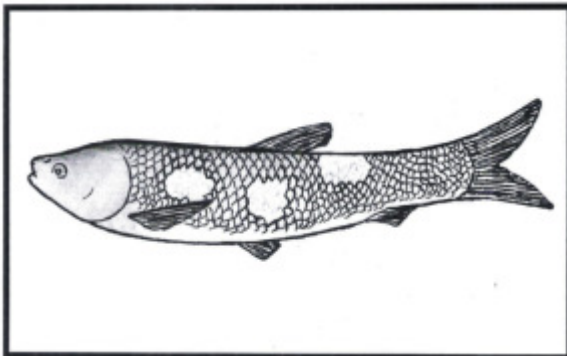

Red or white sores on the body

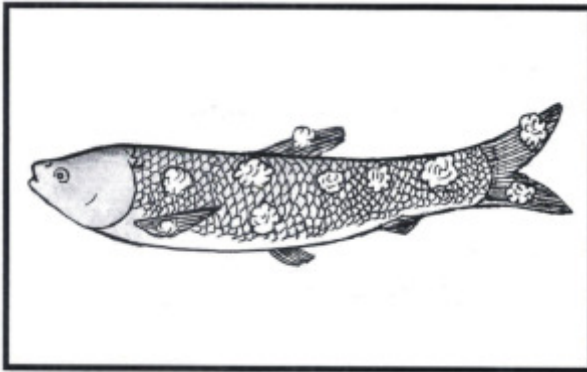

Cotton growth on skin

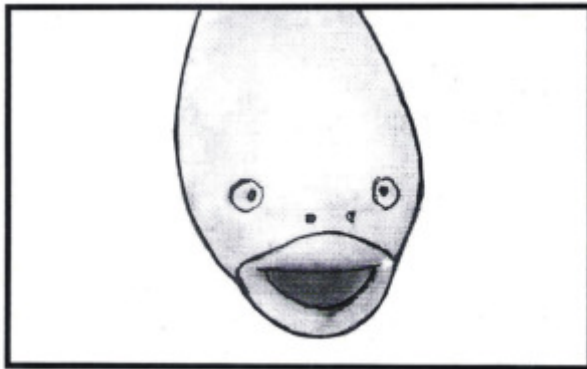

Cloudy or bulging eyes

Remove dead fish from the pond every day.

If you have more than one pond on your farm, each pond must have a separate water inlet.

Water should not flow from one pond to the next.

Disease can pass from one pond to the next with water.

Stopping wild fish from entering pond can limit the spread of sickness.

Screen inlets to limit the entry of wild fish.

Controlling pests and predators – such as birds, frogs, snails — can prevent some kinds of sickness.

Keep the grass on pond dikes cut short.

Throw grass into pond.

Handling fish too much can cause damage to the skin and lead to sickness.

Do not stock baby fish that are sick into a pond.

See how baby fish are swimming in the plastic bag for transport.

Do not stock too many fish.

The cost of treating a pond with medicine or chemicals is very high. It is often not worth the money to treat sick fish.

Drying the pond between crops can help control some kinds of sickness.

Liming the pond bottom between crops with quicklime can help control some kinds of sickness.

Harvesting / Netting

A cast net can be used to catch a few fish for the household.

A gill net can be used to selectively remove larger fish.

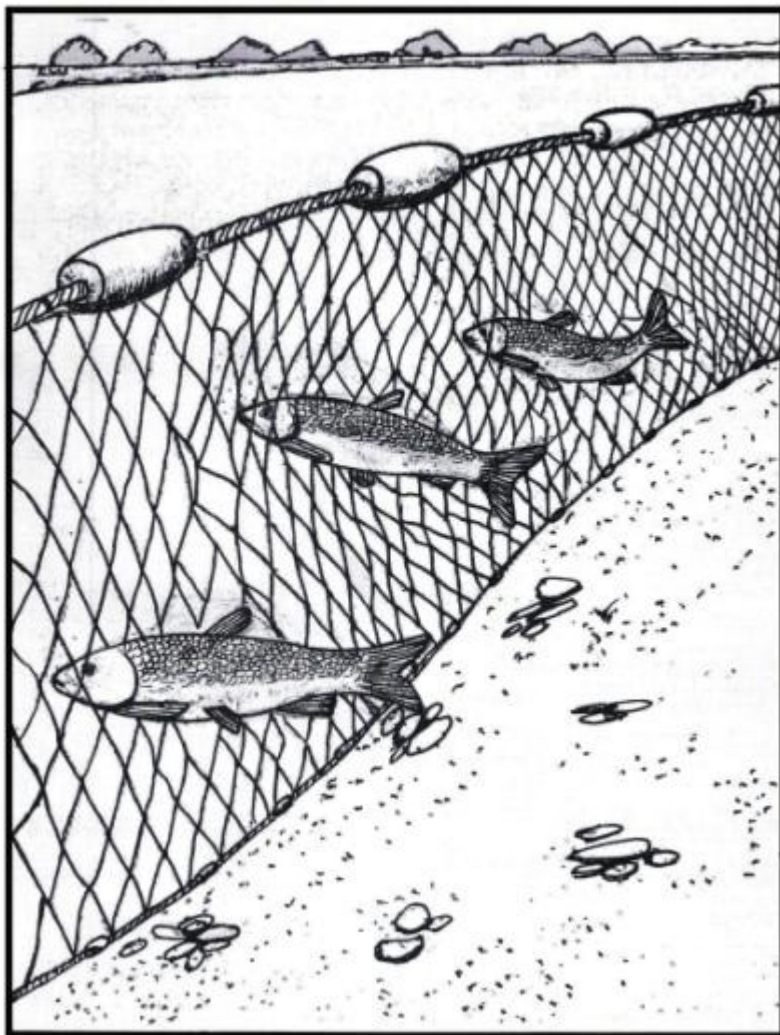

A seine net can be used to capture all fish.



The length of the seine net should be half again as long as the pond is wide. If a pond is 20 m wide then the seine net should be 30 m long. (Pond width + 0.5*pond width is 20 + 10 is 30.)
Do not feed fish for three days before harvesting.
Drain pond water by half before seining.
Begin draining before dawn.

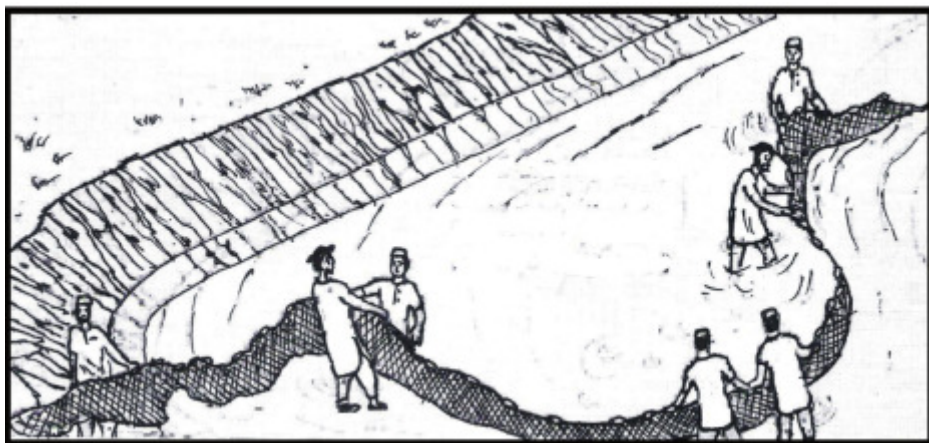
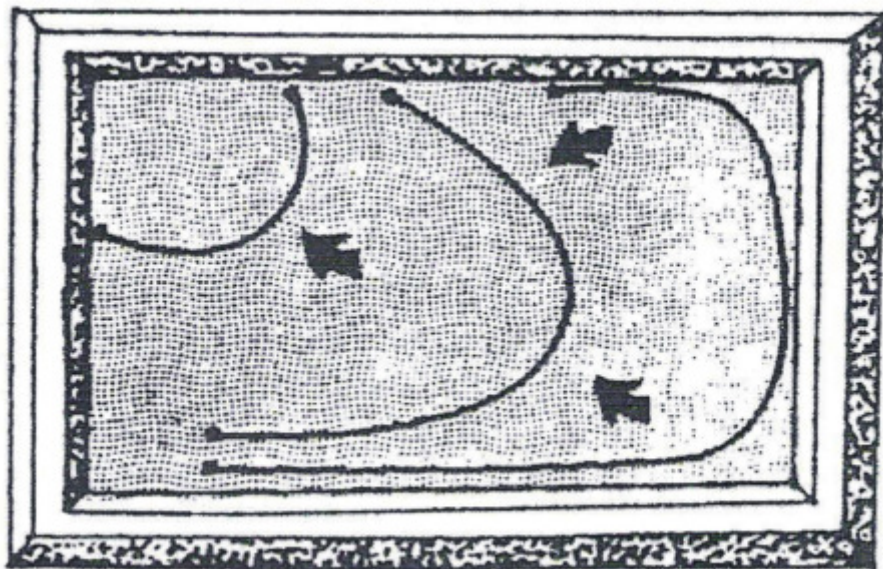

Pass the net two or three times through the pond to capture as many fish as possible.

Drain the remaining water.

Collect the remaining fish from the pond bottom by hand.

Allow the pond to dry.

Marketing

Harvest when price is high and when fish have reached 1 kg or more.

Arrange for marketing before harvest.

Try to keep fish alive after harvest because market value is high.

If it is not possible to keep fish alive, then try to keep fish cold with ice to prevent spoilage.

Fish spoil easily and must be marketed quickly before quality is lost.

Fish harvested from ponds can be eaten, given to relatives, or sold.

Eat fish in home.

Give fish to relatives and visitors.

Sell fish in village or district market.

Sell fish in city market.

Sell fish to restaurants.

Sell live fish.

Try to sell fish during times of year when fish are scarce and prices are high.

Cost Items for Fish Production

Costs to dig pond

Water pump

Fuel for pumping water in or out of pond

Screens for inlet and outlet

Lime

Fertilizers (DAP, urea)

Baby fish for stocking ponds

Transport of baby fish

Feeds from off-farm (such as wheat bran)

Nets to catch fish

Medicines or chemicals to treat sick fish

**Get more e-books from www.ketabton.com
Ketabton.com: The Digital Library**